

Mikron

MILL X

400 / 400 U

600 / 600 U / 800



Becoming better every day – since 1802

GF Machining Solutions

When all you need is everything, it's good to know that there is one company that you can count on to deliver complete solutions and services. From unmatched Electrical Discharge Machining (EDM), Laser texturing, Laser micromachining, Additive Manufacturing and first-class Milling and Spindles to Tooling and Automation, all of our solutions are backed by unrivaled Customer Services and expert GF Machining Solutions training. Our AgieCharmilles, Microlution, Mikron Mill, Liechti, Step-Tec and System 3R technologies help you raise your game—and our digital business solutions for intelligent manufacturing, offering embedded expertise and optimized production processes across all industries, increase your competitive edge.



+ We are Mikron Mill.
We are GF Machining Solutions.

Contents

4	Market segments and applications
6	Technology and Solutions
8	Complex parts in perfection
10	Heidenhain TNC 640 control
11	smart machine
12	Accuracy
14	High-tech motor Spindles
15	Tool magazine
18	Table variants, Tooling and Automation
20	For a single machine with integrated Automation
21	Interface for Automation
22	Chip and mist management
24	Post-processing 3D printed metal parts
26	Our Service + Success range
28	Sustainability
<hr/>	
30	Technical data
33	Customer Services
34	GF Machining Solutions

Since the beginning of high-speed Milling (HSM), GF Machining Solutions has pioneered the development of this technology. The Mikron MILL X series is the result of this continuous development, bringing together the utmost features that make it the reference solution within the industry.

The Mikron MILL X solutions are 3- and 5-Axis extreme high-speed Milling solutions for manufacturers of small, precise and complex light parts.



3-Axis applications



ICT

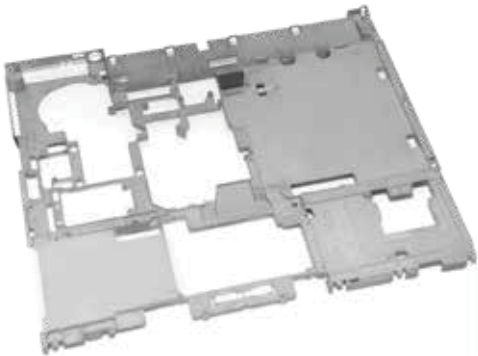

Automotive





5-Axis applications



Medical



Aerospace

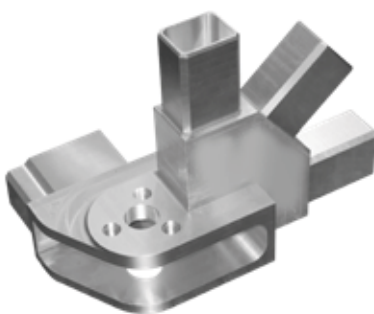

General mechanics



Technology

High-speed Milling (HSM): productive precision and quality for your production

- + Productivity
- + Dynamic accuracy at fastest processing speed
- + Fast setup change for flexible production
- + Sustainable quality in split-batch production



**Part
production
with highest
productivity
and quality**

We have the right solution— for you

- + Integrated or third-party Automation in smallest footprint
- + Unrivalled accessibility with or without Automation
- + Reliable process due to sophisticated thermal management system
- + Best damping characteristics due to mineral cast machine base
- + Direct linear and rotating drives for highest dynamic process
- + smart machine for precision, protection, time and saving energy
- + Remote line assistance
- + Step-Tec Spindle
- + Heidenhain TNC 640 control

- Master the challenges of a wide range of applications and short term-market requirements
- Go from blank to finished part on the smallest footprint, thanks to a flexible 5-Axis machine and produce your part on one machine in a single clamping



Complex parts in perfection

React fast, drive fast and win the race

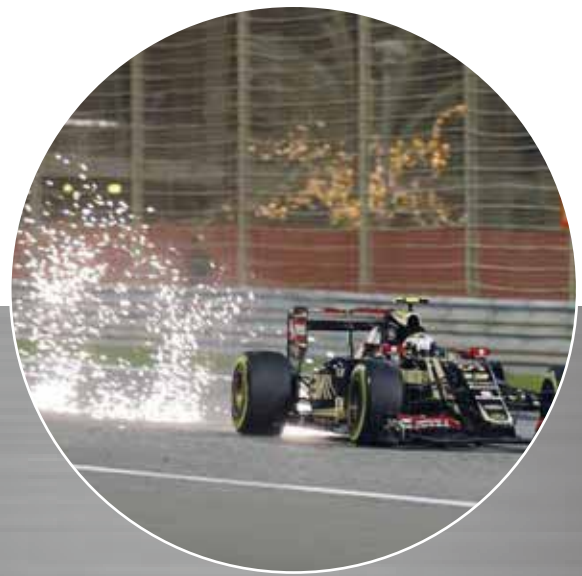

Flexibility

- + 24/7 flexible production
- + Always be able to answer customers' short-notice requests
- + Change from batch production to express job within minutes

**Fulfill market
demands
at any time
just in time**

Productivity

- + Fastest 5-Axis HSM precision solution
- + Ideal machine design with automated 5-Axis machining creates competitive advantages
- + Reliable system for 24/7 production

**Go from
order to
finished part
just fast**

Generate profit around the clock within limited production time



Best practice

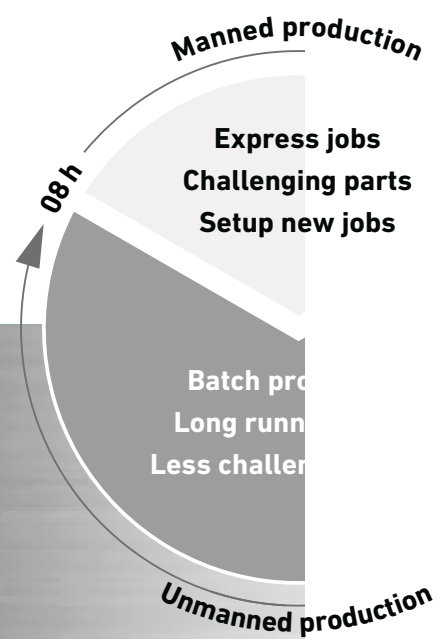

Solution

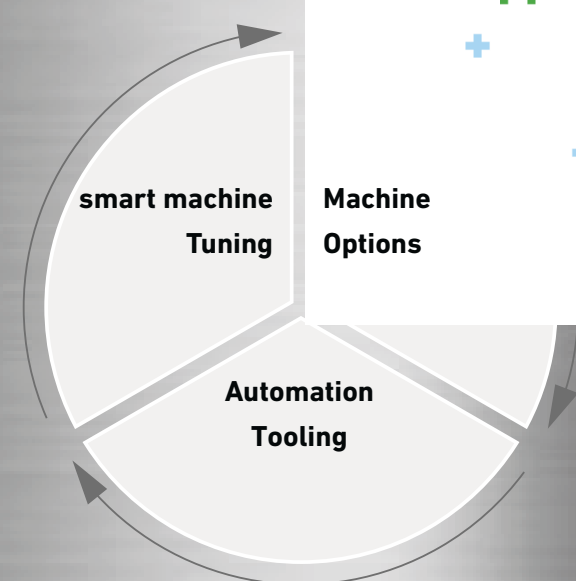

Profitability

- + Complete machining in one setup
- + Optimal productivity with minimal manpower
- + Highest autonomous productivity on smallest footprint
- + Sustainable precision and surface quality
- + Generate value-added profit 24/7

Competitive cost per part just better

Heidenhain TNC 640 control

Optimal machining efficiency is at your fingertip

The Heidenhain TNC 640 control provides flexibility and efficiency from job preparation until part is milled. Mounted on a pivot arm to give more operator's accessibility, the touchable screen allows the operator to quickly navigate through the control. Thanks to an user-friendly and practical interface in combination with several functionalities, the TNC 640 support operators in their daily job giving to them more availability for other tasks.



AMC/OMC

Higher precision from the beginning



AMC

Every MILL X 5 axis machine is featuring the new Automated Machine Calibration (AMC). This new calibration tool comes with the complete Calibration Hardware on a pallet and allows calibrating at any time the kinematic of the machine. Program it or release it manually simply by pressing the start button. Beside the machine kinematic, it will also automatically calibrate touch probe and tool measuring system when needed.



OMC

Every MILL X 3-axis machine is delivered with OMC (Original Manufacturer Calibration). Performed at the original assembly within GF production plant it is a new sequence of the calibration process reducing the machine tolerance. Achieving tight geometric dimensioning and tolerances will be easier.

smart machine

Enhance your process beyond program and machine setup

The smart machine functionalities gathers a range of modules that offers various features in order to make the Milling process "intelligent,"

Each of the modules fulfills a specific task. Just like in a construction kit, the user can select the modules that seem to him to be the best option for improving his process.

- Produce your workpieces in a process-secure and precise manner
- Increase reliability in unmanned operation
- Boost the service life of the machine
- Significantly reduce production costs

Saving energy

smart machine modules like Econowatt, saving up to 50% energy, are ecological necessities with attractive economic advantages.

Time

smart machine modules like OSS and software tools such as rConnect boost your productivity. OSS extreme yields up to 24 % more speed with improved surface finish and accuracy.



Precision

smart machine modules like ITC and OSS support the precise base of your machining center to achieve an even more precise final part.

Protection

smart machine modules like PFP protect and extend the lifetime of your machine and tools.

smart machine classic package

Find your market and tune your machine accordingly

With the new smm package for 3 axis and 5 axis machines GF Machining Solutions combines some of the most powerful smart machine modules for your targeted applications and market needs. This tuning package will support you to get the best out of your machines according to your customer base.

For the 5 axis machines the included AMC extended corrects beside any position errors of the 4th and 5th axis also the angle errors of the swivel and rotary axis.

Accuracy

HSM core components

+ Static accuracy

Perfect machine design with highest mechanical requirements provides the basis for a high-precision machine.

Moreover, GF Machining Solutions spares no effort to implement state-of-the-art components to create the best package for your Milling applications.

+ Dynamic accuracy

Stability, high dynamic drives and ingenious software are primary prerequisites for maximum precision and best workpiece surface quality.

- + Concrete polymer with high thermal inertia and excellent damping properties
- + Optimized force distribution within castings
- + High-precision direct drives and guides for high dynamics and rigidity
- + Direct path measuring system in the linear and rotational axis
- + Intelligent software compensation

+ Thermal accuracy

The Mikron MILL X series leads precision machining into a new era.

Sophisticated temperature management system comprises separate and independent cooling circuits of all heat sources and machine body as follows:

- + X, Y, Z, B, C drives
- + Machine body
- + Spindle with Opticool or CoolCore technology
- + Electronics cabinet

Highest part precision is the ultimate result of this solution's active stabilization enabling highest stability and process reliability.



Z

MILL X 400	360 mm
MILL X 400 U	360 mm
MILL X 600	500 mm
MILL X 600 U	500 mm
MILL X 800	500 mm

- Comprehensive and reliable Milling solution for light material parts production as a result of machine design, core components and complete process know-how

Y

MILL X 400	450 mm
MILL X 400 U	240 mm
MILL X 600	600 mm
MILL X 600 U	600 mm
MILL X 800	600 mm

n x 360° Tilting axis
+110/-110° Swivelling axis

X

MILL X 400	500 mm
MILL X 400 U	500 mm
MILL X 600	600 mm
MILL X 600 U	800 mm
MILL X 800	800 mm

High-tech motor Spindles

HSM core components from Step-Tec

- Your reliable and stable Milling process is secured, thanks to an ingenious temperature control system

OptiCool

Step-Tec's OptiCool Spindle series ensures not only that the Spindle remains thermally stable, but that natural heat transfer to the Spindle support (e.g., Z-Axis) is limited to the lowest amount possible, in order to preserve the machine's geometry.

- Best polar thermal balance around the surface contacting the machine support
- Ultra high-precision ceramic hybrid bearings
- Heat barrier
- Frontal cooling
- Highest precision due to optimized thermal balance of the entire machining head
- Satisfies the toughest requirements in surface finish, repeatability and reliability

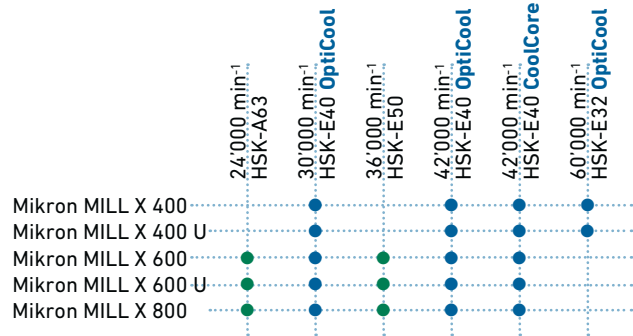
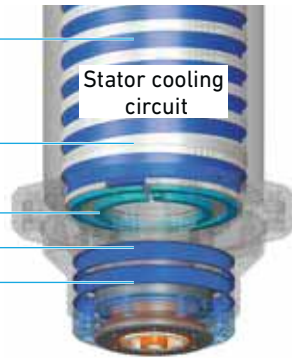

HPC 170 / 24,000 min⁻¹

Step-Tec's versatile Spindle for mold and part production.

- Versatile Spindle for use in both mold making and production
- High chip volume due to large HSK-A63 tool interface
- Good surface finish in mold making
- Great rigidity for machining lightweight material (impeller) with long tools
- Full vibration control (V3D) to maximize the feed rate
- Constant power up to maximum speed

Cutting conditions monitoring

- Vibration monitoring along each Axis
- Temperature monitoring of hot spots (bearings, motor, ambient temperature)

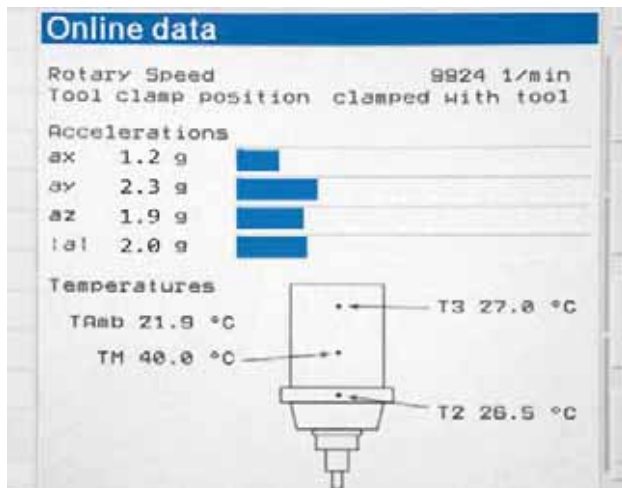

Spindle power

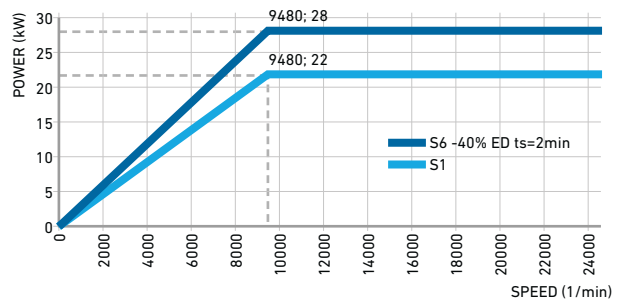

Spindle torque

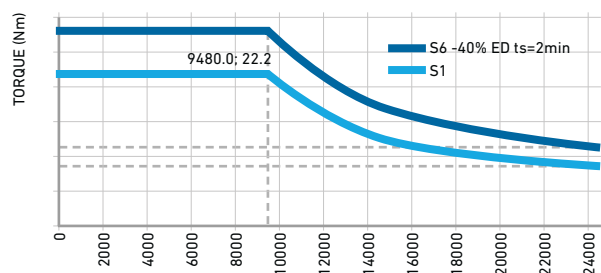



Tool magazine

Individual solutions tailored to your production needs

User-friendly tool feeding

Productivity and process reliability are ensured by lateral tool feeding.

- + Simultaneous machining and feeding
- + Simple feed monitoring through large glass panel
- + Ergonomic access

Tool Automation in every configuration level

- + Simple, double-row disc magazine or ATC
- + Reliable "pickup" changing system
- + Feed control via light beam
- + Orientation of the touch probe

Optionally available in a variety of capacities:

- + Mikron MILL X 400, MILL X 400 U
HSK-E40: 18, 36, 68, 168 tools
HSK-E32: 20, 40 tools
- + Mikron MILL X 600, MILL X 600 U, MILL X 800
HSK-E50: 15, 30, 60, 120, 170, 220 tools
HSK-E40: 18, 36, 68, 168, 308 tools
HSK-A63: 48, 120, 170, 220 tools



**Productivity
with pinpoint
accuracy**

+GF+
Step-Te
Switzerland



As flexible as needed

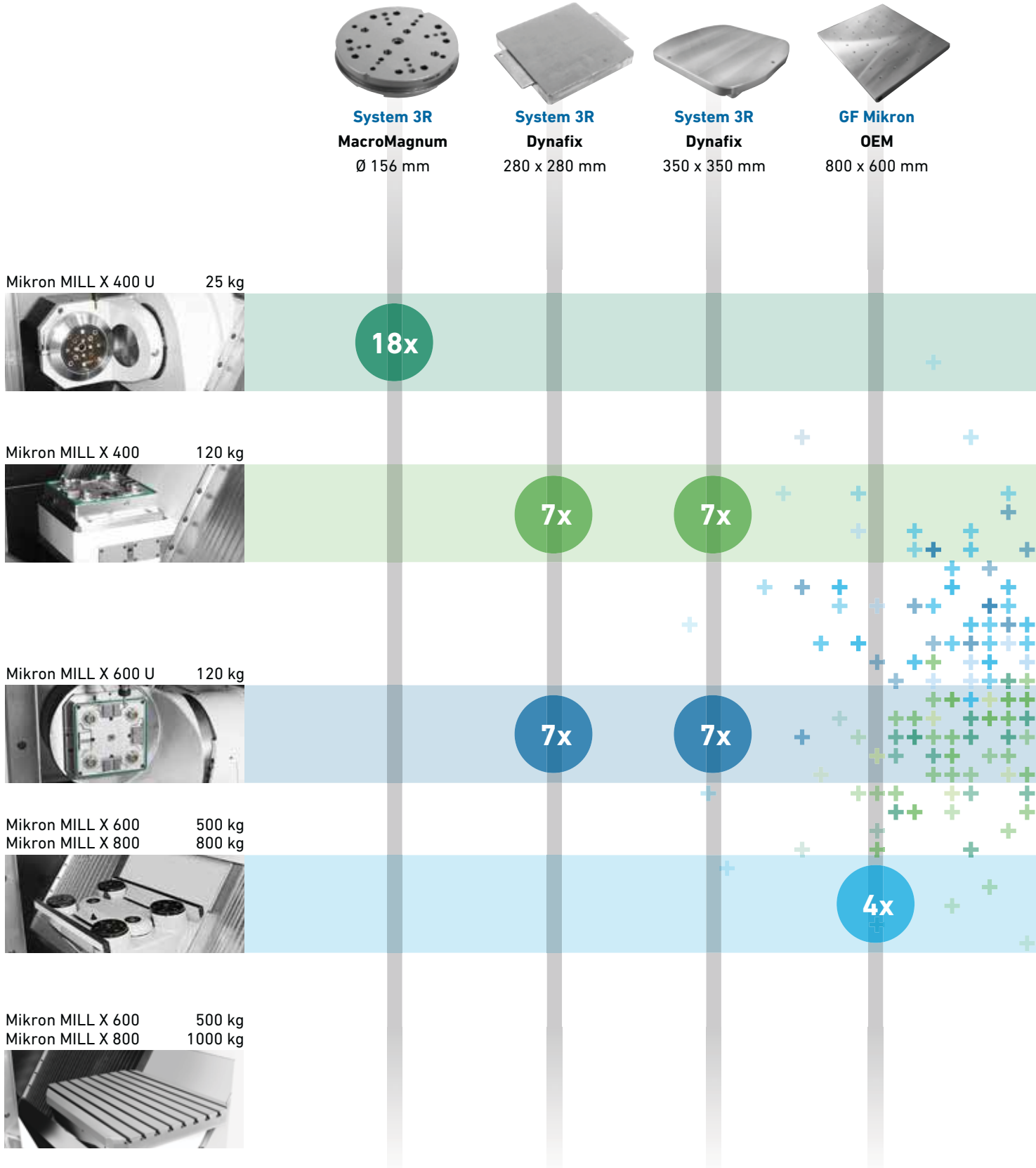

- Increase your productivity by reducing your setup time with a zero-point clamping system
- Increase your quality by improving repeatability with Tooling and Automation

Easy loading and unloading of pallet magazine during the machining process



**Erowa
ITS**
Ø 148 mm



**Erowa
UPC**
320 x 320 mm

20x

7x

7x

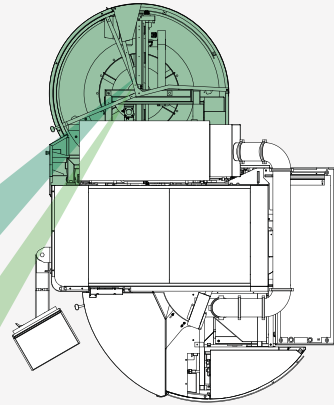

Mikron MILL X 400 / 400 U: disc-type magazine

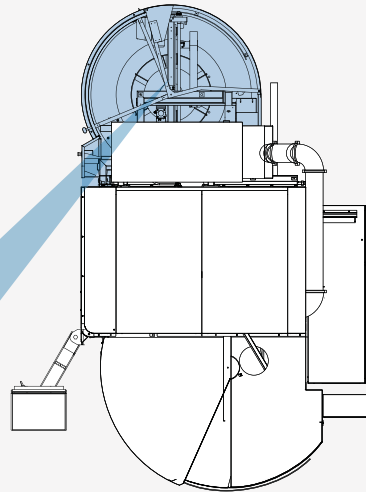

Mikron MILL X 600 U: disc-type magazine

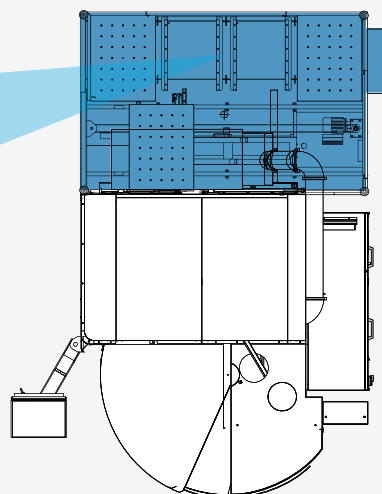

Mikron MILL X 600 / 800: linear-type magazine

For a single machine with integrated Automation

Job Tool Manager (JTM) - bring agility back to the shop floor

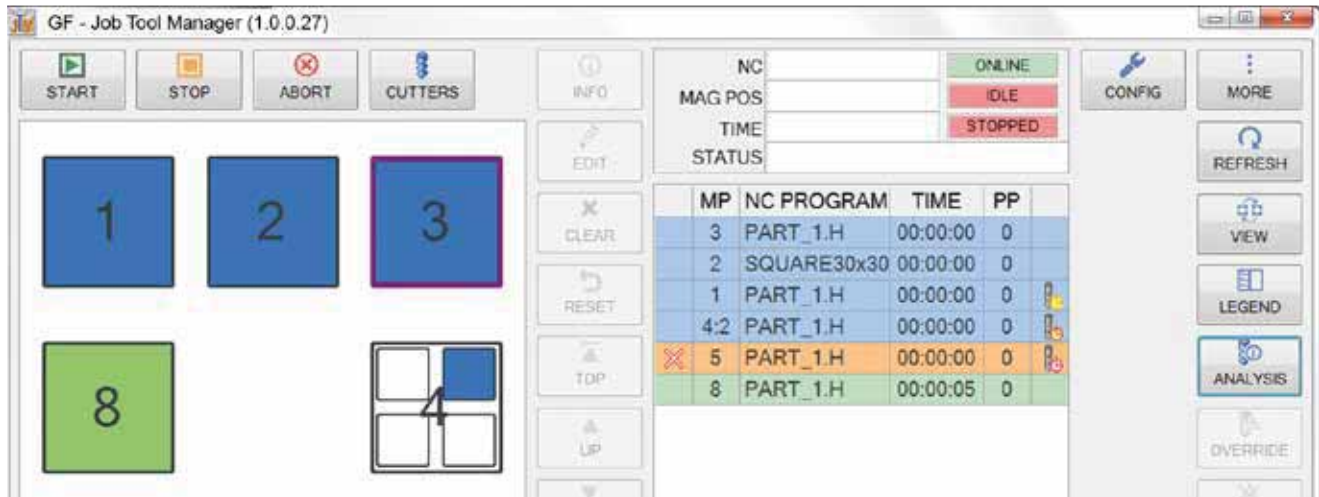

User friendly software for one machine with integrated pallet changer. Assign NC programs to pallet position by drag and drop on a touch screen, close to the pallet changer.

Advantages

- + Easy to change priorities when the machine is working
- + Add or remove jobs while machining
- + Jobs where cutters are missing will not be started
- + Estimated and present machining time for the magazine content are calculated.

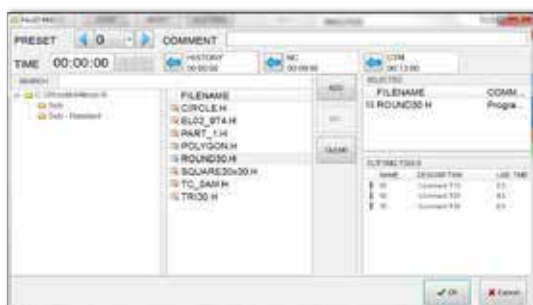

Assign NC file, check tool capacity, schedule

By selecting the NC program, JobToolManager register the tools used in the in the program.

Time is stored if the NC program defines the time for the entire machining or if each tool has its use time.

If the program has been used earlier, it automatically displays the last recorded time.

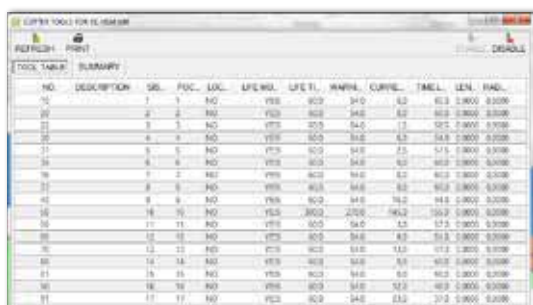

Manage tools upon jobs to be done

Each time a new job is started, JobToolManager checks the machine tool table to see the availability of tools.

If a tool is broken and no sister tool is available, will the job be blocked.

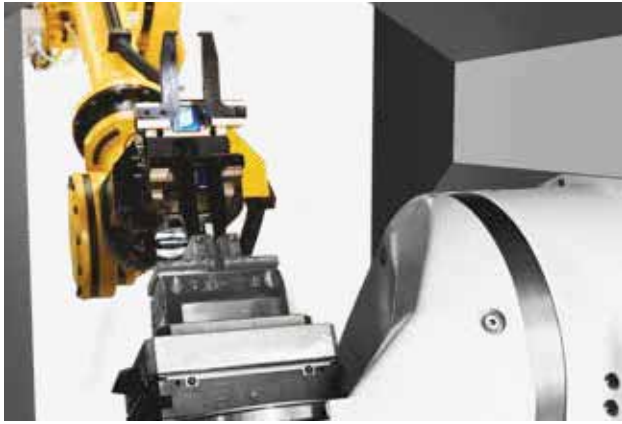

Customer-specific solutions

From the pallet magazine to the robot system

GF Machining Solutions has developed a fully integrated pallet magazine as a standard product.

With a standardized robot interface, the Mikron MILL X series can be operated with well-known suppliers' robot systems.

No matter what type of handling system is used, the accessibility of the machine remains outstanding.

Together with the modular tool magazines, the compact Milling center becomes a highly productive and flexible production cell—including in conjunction with other machines.

- More parts in less time at lower costs

A complete cell, configured for you



Chip and mist management

Clean machining

Adapted chip and mist management

The form and volume of the chips are determined by the machined material as well as the processing strategy. Whatever your production process, a wide selection of options is available to ensure proper chip evacuation.

Optimum chip clearance due to steep, smooth cabin walls. Washer jets prevent chip accumulation.

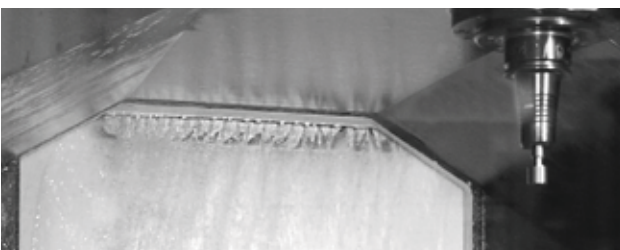

Automation door is also washed down.

Chip conveyor



Lift-up chip conveyor

- + Solution for aluminum Milling chips. With slat band lift-up chip conveyor and coolant filtration unit
- + Solution for steel Milling chips with scraper lift-up chip conveyor and coolant filtration unit



Band filter system

Depending on machine equipment and processing strategy, 450- and 950-liter filter systems are available.

- + Pump back station
- + Lift pump station
- + Wash-down system

Already implemented requests

- + Air/cooling lubricant through Spindle
- + Additional chip flushing on the Spindle

Cooling lubricant/air through Spindle



**Productivity
for you**



Post-processing 3D printed metal parts

Technologies combination as a goal

- Revolutionize your manufacturing process
- Decrease your lead time
- Complete freedom of design



Freedom of design
Additive Manufacturing



Perfect surface
High-speed cutting (HSC) Milling /
high-speed part production

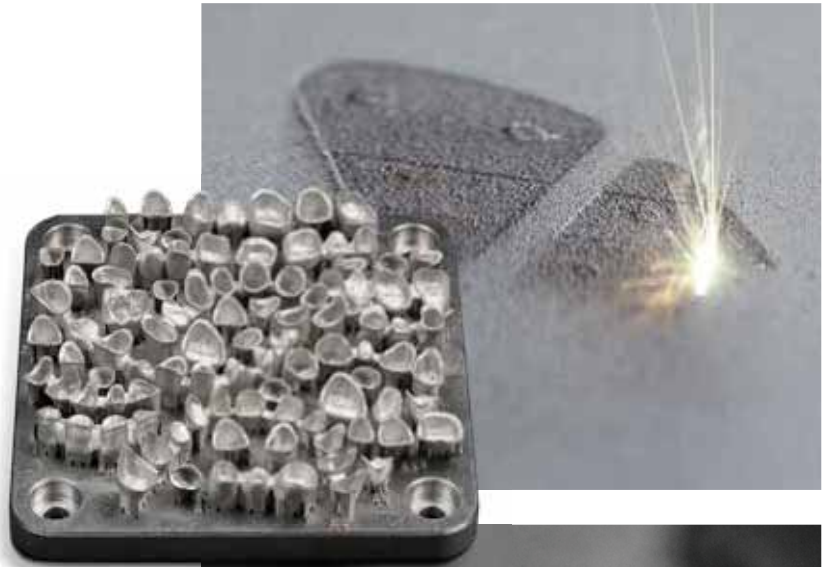

Additive Manufacturing (AM) is a hot industrial topic as applications are numerous and promising—and initiatives are multiplying all over the world.

GF Machining Solutions has embraced AM as a leading technology providing new opportunities for its customers, and understands how it complements traditional technologies.

Combining AM and—for example—a Mikron MILL X Milling machine is the most efficient option if you want to build parts with a perfect surface finish.

The future is in complete solutions combining performant technologies in an efficient way, and GF Machining Solutions is your partner on the path to the future. And—just as we have pioneered the Automation of traditional machining technologies—we are blazing a path for AM Automation.



**Your most
efficient
option**



Our Service + Success range

We take you to new heights

Guiding your ascent

Whether it is Milling, EDM, Laser Texturing or Additive Manufacturing, our Service + Success experts guide you throughout the entire lifecycle of our Machining and Automation tools in order to help you reach your peak performance. Our trusted experts backed by our latest cutting-edge, intelligent Digital Solutions, provide a full range of services.



Operational steering
Hands-on and operational service interventions with supply of consumables and wear parts



Advanced diagnosis
Machine check-up, preventive maintenance and advanced services including original spare parts availability in all our hubs around the world

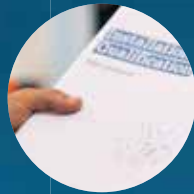

Certification
State-of-the-art reference by industry sector and on machining equipment



Upgrades
Designed to add value to the original machine investment in order to achieve higher sustainable productivity



Training
Performance oriented academy with a human-centric approach of knowledge transfer in order to realize the full potential of our solutions



Transformation
Strategic partnership from made-to-measure advice on business model evolution to industrial implementation



Financial solutions
For the optimization of operating costs featuring minimal initial expenditure programs and leasing options

Our Success Packs

As a long-time partner, since 1802 we have been serving various industrial segments and have been dedicated to providing you with a first-in-class combination of services.

We have conceived our new Success Packs range for maximizing your return on investment, empowering you in your quest for success whatever your industrial profile.



Silver +
Secure
your future



Silver
Set the foundation
for growth



Bronze +
Achieve flawless
production



Bronze
Get back on
track fast



Sustainability

Focus on energy efficiency

The new generation of the 5-axis MILL X U series can achieve reductions of 7 % in daily energy consumption, compared to the previous generation. This improvement is made possible thanks to a change to a new CNC, the Heidenhain TNC 640, the implementation of a Venturi nozzle in the exhauster system, which reduces the compressed air usage, and an intelligent temperature control compensating the temperature variations.



MILL X U series

Energy Efficiency Certificate



Operating mode (24h cycle time)	XSM U LP (2015)	MILL X U (2020)	Energy saving %	Thanks to GF MS
Standby (4h)	7.9 kW	7.0 kW	-11%	1,2,3
Ready (4h)	8.9 kW	7.0 kW	-21%	1,2,3
Machining (16h)	13.6 kW	13.1 kW	-4%	1,2,3,4
Daily Energy Consumption	285 kWh	266 kWh	-7%	

1 // New control generation
The change to a new CNC, Heidenhain TNC 640, improves the control efficiency.

2 // Highly efficient exhauster system
The implementation of a Venturi nozzle in the exhauster system helps to significantly reduce the compressed air usage.

3 // Design
Several design changes, like switching to LED lights, also help improve the energy efficiency.

4 // ITC – Intelligent Temperature Control
The continuous improvements made on this software help compensate the temperature fluctuations and also significantly increase the already improved precision of the new generation of Milling machines.

Equivalent to, over 1 year greenhouse gas and CO₂ emissions from



427 496
smartphones charged



carbon sequestered by
58
tree seedlings grown for 10 years



14 213
kilometers driven by an average passenger car

Source: www.epa.gov

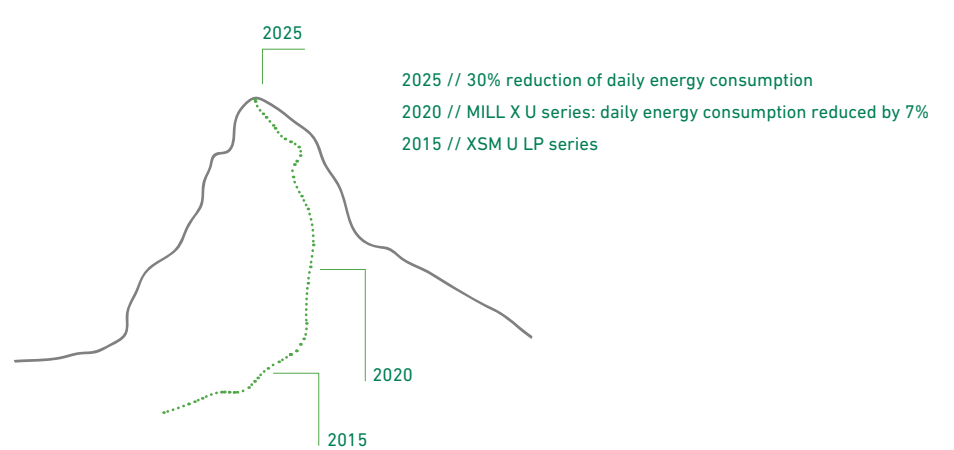

Technical data



Machine			Mikron MILL X 400	Mikron MILL X 400 U
Workarea				
Longitudinal	X	mm	500	500
Lateral	Y	mm	450	240
Vertical	Z	mm	360	360
Swivelling axis		°	-	+110/-110
Rotary axis		°	-	n x 360
Feed rate				
Rapid traverse	X, Y	m/min	100	100
Rapid traverse	Z	m/min	100	100
Rapid traverse (swivel)		rpm	-	165
Rapid traverse (rotary)		rpm	-	250
Working spindle (40% ED, S6)				
60,000 rpm, HSK-E32		kW / Nm	8.5 / 3.5	8.5 / 3.5
42,000 rpm, HSK-E40		kW / Nm	13.5 / 8.8	13.5 / 8.8
30,000 rpm, HSK-E40		kW / Nm	13.5 / 8.8	13.5 / 8.8
Work table				
Table		mm	-	-
Pallet/clamping surface		mm	Dynafix 280x280/350x350	MacroMagnum 156
Pallet/clamping surface		mm	UPC 320 x 320	ITS 148
Max. table load		kg	120	25
Tool magazine				
HSK-E32	tool holder		20/40	20/40
HSK-E40	tool holder		18 / 36 / 68 / 168	18 / 36 / 68 / 168
Automation				
Pallet size / Number	Piece		-	MacroMagnum 156 / 18x
Pallet size / Number	Piece		Dynafix/UPC / 7x	ITS 148 / 20x
Maximum additional load	kg		90	25
Weight				
Machine		kg	6,800	7,000
Pallet magazine		kg	900	900
Control unit				
Heidenhain			TNC 640	TNC 640



Machine			Mikron MILL X 600	Mikron MILL X 600 U	Mikron MILL X 800
Workarea					
Longitudinal	X	mm	600	800	800
Lateral	Y	mm	600	600	600
Vertical	Z	mm	500	500	500
Swivelling axis		°	-	+ 30/-110°	-
Rotary axis		°	-	n x 360°	-
Feed rate					
Rapid traverse	X, Y	m / min	100	100	100
Rapid traverse	Z	m / min	100	100	100
Rapid traverse (swivel)		rpm	-	60	-
Rapid traverse (rotary)		rpm	-	150	-
Working spindle (40% ED, S6)					
42,000 rpm, HSK-E40		kW / Nm	13.5 / 8.8	13.5 / 8.8	13.5 / 8.8
36,000 rpm, HSK-E50		kW / Nm	33 / 21	33 / 21	33 / 21
30,000 rpm, HSK-E40		kW / Nm	13.5 / 8.8	13.5 / 8.8	13.5 / 8.8
24,000 rpm, HSK-A63		kW / Nm	28 / 28	28 / 28	28 / 28
Work table					
Table		mm	900 x 600	-	900 x 600
Pallet/clamping surface		mm	-	Dynafix 280x280/350x350	-
Pallet/clamping surface		mm	800 x 600	UPC 320 x 320	600/800 x 600
Max table load		kg	500	120	1,000
Tool magazine					
HSK-E40	tool holder		18 / 36 / 68 / 168	18 / 36 / 68 / 168	18 / 36 / 68 / 168
HSK-E50	tool holder		15/30/60/120/170/220	15/30/60/120/170/220	15/30/60/120/170/220
HSK-A63	tool holder		48 / 120 / 170 / 220	48 / 120 / 170 / 220	48 / 120 / 170 / 220
Automation					
Pallet size / Number	Piece		800 x 600 / 4x	Dynafix/UPC / 7x	800 x 600 / 4x
Maximum additional load	kg		500	90	800
Weight					
Machine		kg	9,900	9,900	9,900
Pallet magazine		kg	900	900	1,800
Control unit					
Heidenhain			TNC 640	TNC 640	TNC 640

Mikron MILL X 400 / 400 U

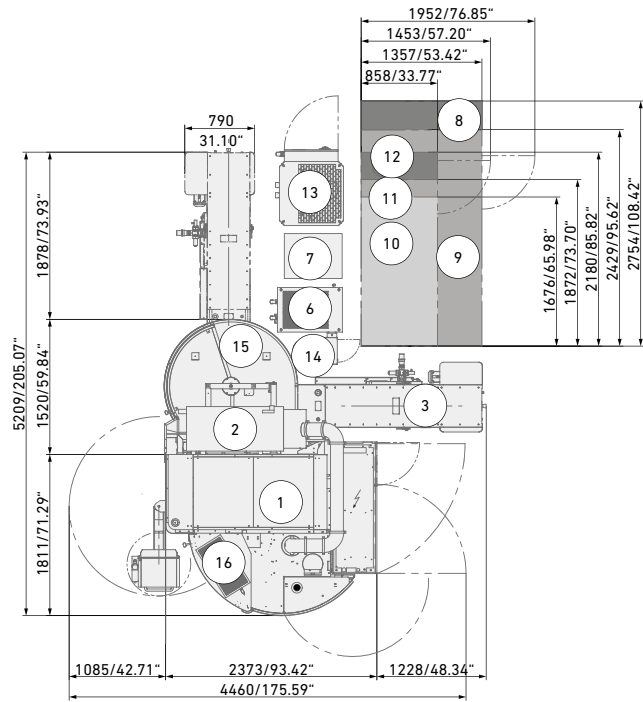
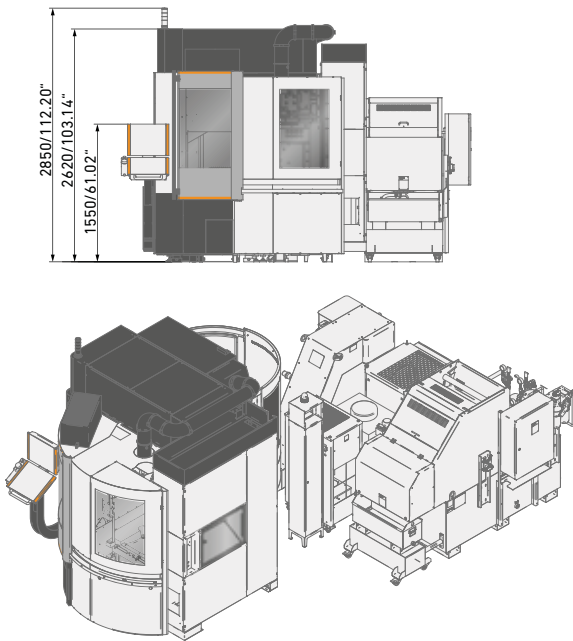

1. Machine
2. Mist extraction unit
3. Lift-up chip conveyor (scraper and slat-band types)
6. Cooling unit
7. CoolCore cooling unit
8. Endless belt filter system (950 liters)
9. Band filter system (950 liters)
10. Basket filter system (450 liters)
11. Band filter system (450 liters)
12. Endless belt filter system (450 liters)
13. Coolant thermal control
14. CO² fire extinguishing system
15. Pallet magazine
16. Pressure-relief damper

Mikron MILL X 600 / 600 U / 800

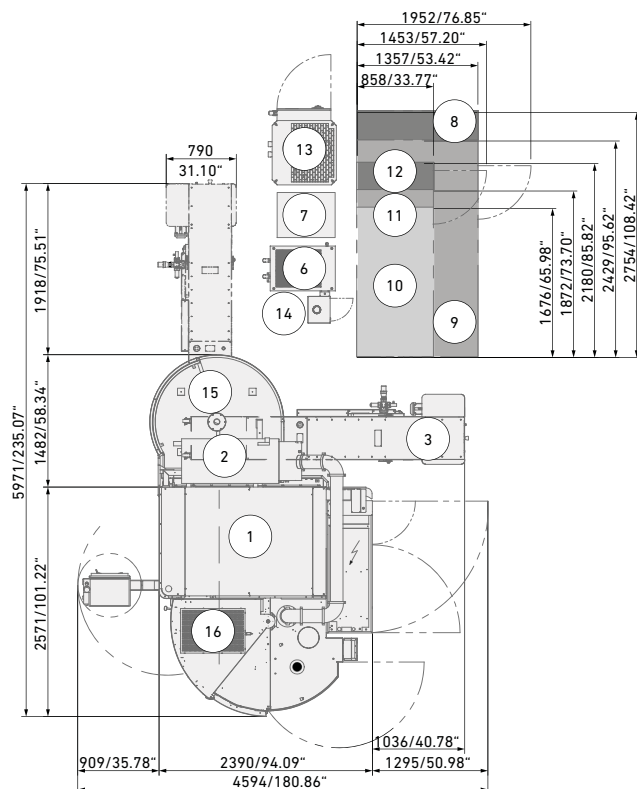
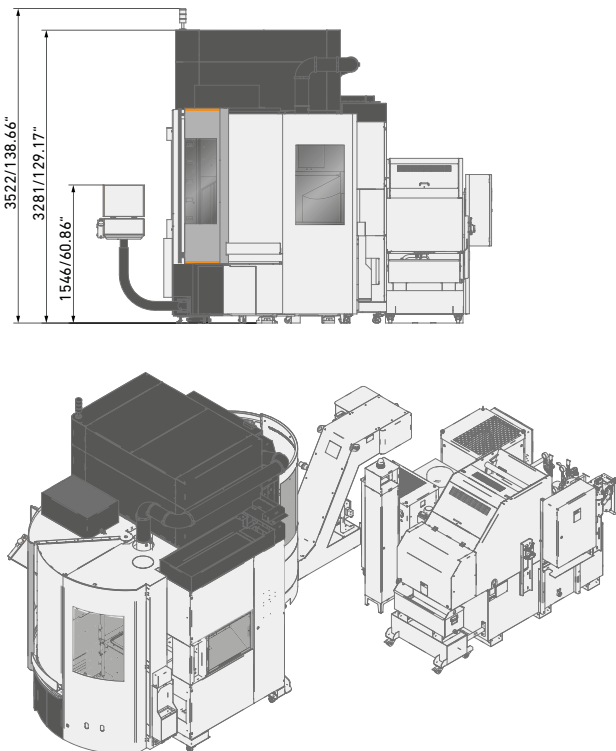

Customer Services

New digital service possibilities

GF Machining Solutions Customer Services continues to push technological boundaries to deliver the future of services to you—today.



rConnect is the digital services platform available for all GF Machining Solutions technologies. Following a modular approach, rConnect comprises a range of services that empower you to increase your manufacturing productivity. Certified with the TÜViT Trusted Product Certificate.

rConnect Messenger, we deliver machine data to your mobile device to keep you constantly informed about your production. You can supervise your workshop from your smartphone.

rConnect Live Remote Assistance (LRA), our expert engineers rapidly respond to your service requests. LRA allows effective face-to-face assistance using audio, video, chat and many more functionalities.



rConnect

About GF Machining Solutions

Multi-technology solutions provider

Our commitment to you and your specific applications is proven by the value-adding intelligence, productivity and quality delivered by our multi-technology solutions. Your success is our chief motivator. That's why we are continuously advancing our legendary technical expertise. Wherever you are, whatever your market segment and whatever the size of your operation, we have the complete solutions and the customer-centric commitment to accelerate your success—today.

EDM (electrical discharge machining)



Wire-cutting EDM

GF Machining Solutions' wire-cutting EDM is fast, precise and increasingly energy efficient. From ultraprecise machining of miniaturized components down to 0.02 mm to powerful solutions for demanding high-speed machining with respect to surface accuracy, our wire EDM solutions position you for success.

Die-sinking EDM

GF Machining Solutions is revolutionizing die-sinking EDM with features like iGAP technology to dramatically boost machining speed and reduce electrode wear. All of our die-sinking systems offer fast removal and deliver mirror finishes of Ra 0.1 µm (4 µin).

Hole-drilling EDM

GF Machining Solutions' robust hole-drilling EDM solutions enable you to drill holes in electrically conductive materials at a very high speed—and, with a five-axis configuration, at any angle on a workpiece with an inclined surface.

Milling



Milling

Precision tool and mold manufacturers enjoy a competitive edge with our Mikron MILL S solutions' fast and precise machining. The Mikron MILL P machines achieve above-average productivity thanks to their high performance and Automation. Customers seeking fastest return on investment benefit from the affordable efficiency of our MILL E solutions.

High Performance Airfoil Machining

Our Liechti turnkey solutions enable the highly dynamic manufacturing of precision airfoils. Thanks to their unique performance and our expertise in airfoil machining, you increase productivity by producing at the lowest cost per part.

Spindles

As part of GF Machining Solutions, Step-Tec is engaged in the very first stage of each machining center development project. Compact design combined with excellent thermal and geometric repeatability ensure the perfect integration of this core component into the machine tool.

Advanced manufacturing



Laser texturing

Aesthetic and functional texturing is easy and infinitely repeatable with our digitized Laser technology. Even complex 3D geometries, including precision parts, are textured, engraved, microstructured, marked and labeled.

Laser micromachining

GF Machining Solutions offers the industry's most complete line of Laser micromachining platforms optimized for small, high-precision features to meet the increasing need for smaller, smarter parts to support today's leading-edge products.

Laser Additive Manufacturing (AM)

GF Machining Solutions and 3D Systems, a leading global provider of additive manufacturing solutions and the pioneer of 3D printing, have partnered to introduce new metal 3D printing solutions that enable manufacturers to produce complex metal parts more efficiently.

Tooling and Automation



Tooling

Our customers experience complete autonomy while maintaining extreme accuracy, thanks to our highly accurate System 3R reference systems for holding and positioning electrodes and work pieces. All types of machines can easily be linked, which reduces set-up times and enables a seamless transfer of workpieces between different operations.

Automation

Together with System 3R, we also provide scalable and cost-effective Automation solutions for simple, single machine cells or complex, multi-process cells, tailored to your needs.

Software



Digitalization solutions

To drive its digital transformation, GF Machining Solutions acquired symmedia GmbH, a company specialized in software for machine connectivity. Together, we offer a complete range of Industry 4.0 solutions across all industries. The future requires the ability to adapt quickly to continual digital processes. Our intelligent manufacturing offers embedded expertise, optimized production processes, and workshop Automation: solutions for smart and connected machines.

Customer Services



Worldwide for you

Ensuring the best performance throughout the lifetime of our customers' equipment is the goal of our three levels of support. Operations Support offers the complete range of original wear parts and certified consumables. Machine Support includes spare parts, technical support, and a range of preventive services to maximize machine uptime. Business Support offers customer-specific business solutions.



Switzerland

Biel/Bienne
Losone
Geneva
Flawil
Langnau

www.gfms.com
www.gfms.com/ch

Europe

Germany, Schorndorf
www.gfms.com/de

United Kingdom, Coventry
www.gfms.com/uk

Italy, Agrate Brianza - MI
www.gfms.com/it

Spain, Sant Boi de Llobregat
Barcelona
www.gfms.com/es

France, Palaiseau
www.gfms.com/fr

Poland, Raszyn / Warsaw
www.gfms.com/pl

Czech Republic, Brno
www.gfms.com/cz

Sweden, Vällingby
www.gfms.com/system3r

Turkey, Istanbul
www.gfms.com/tr

Americas

USA
Lincolnshire, IL
Chicago, IL
Holliston, MA
Huntersville, NC
Irvine, CA
Woodridge, IL
www.gfms.com/us

Canada, Mississauga ON
www.gfms.com/us

Mexico, Monterrey NL
www.gfms.com/us

Brazil, São Paulo
www.gfms.com/br

Asia

China
Beijing, Shanghai, Chengdu, Dongguan,
Hongkong, Changzhou
www.gfms.com/cn

India, Bangalore
www.gfms.com/sg

Japan
Tokyo, Yokohama
www.gfms.com/jp

Korea, Seoul
www.gfms.com/kr

Malaysia, Petaling Jaya
www.gfms.com/sg

Singapore, Singapore
www.gfms.com/sg

Taiwan
Taipei, Taichung
www.gfms.com/tw

Vietnam, Hanoi
www.gfms.com/sg

At a glance

We enable our customers to run their businesses efficiently and effectively by offering innovative Milling, EDM, Laser, Additive Manufacturing, Spindle, Tooling and Automation solutions. A comprehensive package of Customer Services completes our proposition.

www.gfms.com

